

cucine moderne | modern kitchens | cuisines modernes | las cocinas modernas

Collection living



Arredo3

CUCINE

.01

Lo spazio living si estende con leggerezza sulle pareti, grazie alla boiserie in finitura Kali ecomalta silicio e Kali noce Italia. Le fasce modulari donano slancio orizzontale e si fondono con le basi in Time laccato lucido carruba e i pensili in Kali noce Italia.

The living space extends gently along the walls, thanks to wall panelling in Kali eco-silica mortar and Kali Italian walnut. Modular panels offer a striking horizontal effect, blending in with base units in Time gloss carob lacquer and wall units in Kali Italian walnut.

L'espace living s'étend avec légèreté sur les murs, grâce aux boiseries en Kali ecomalta silicium et Kali noyer Italia. Les bandes modulaires apportent un élan horizontal et s'unissent avec les bases en Time laqué brillant carruba et les éléments en Kali noyer Italia.

El espacio living viste con ligereza las paredes, gracias a la boiserie acabado Kali ecomortero silicio y Kali nogal italiano. Los paneles modulares otorgan un dinamismo horizontal y se funden con los muebles bajos de Time lacado brillante de algarroba y los muebles altos de Kali nogal italiano.



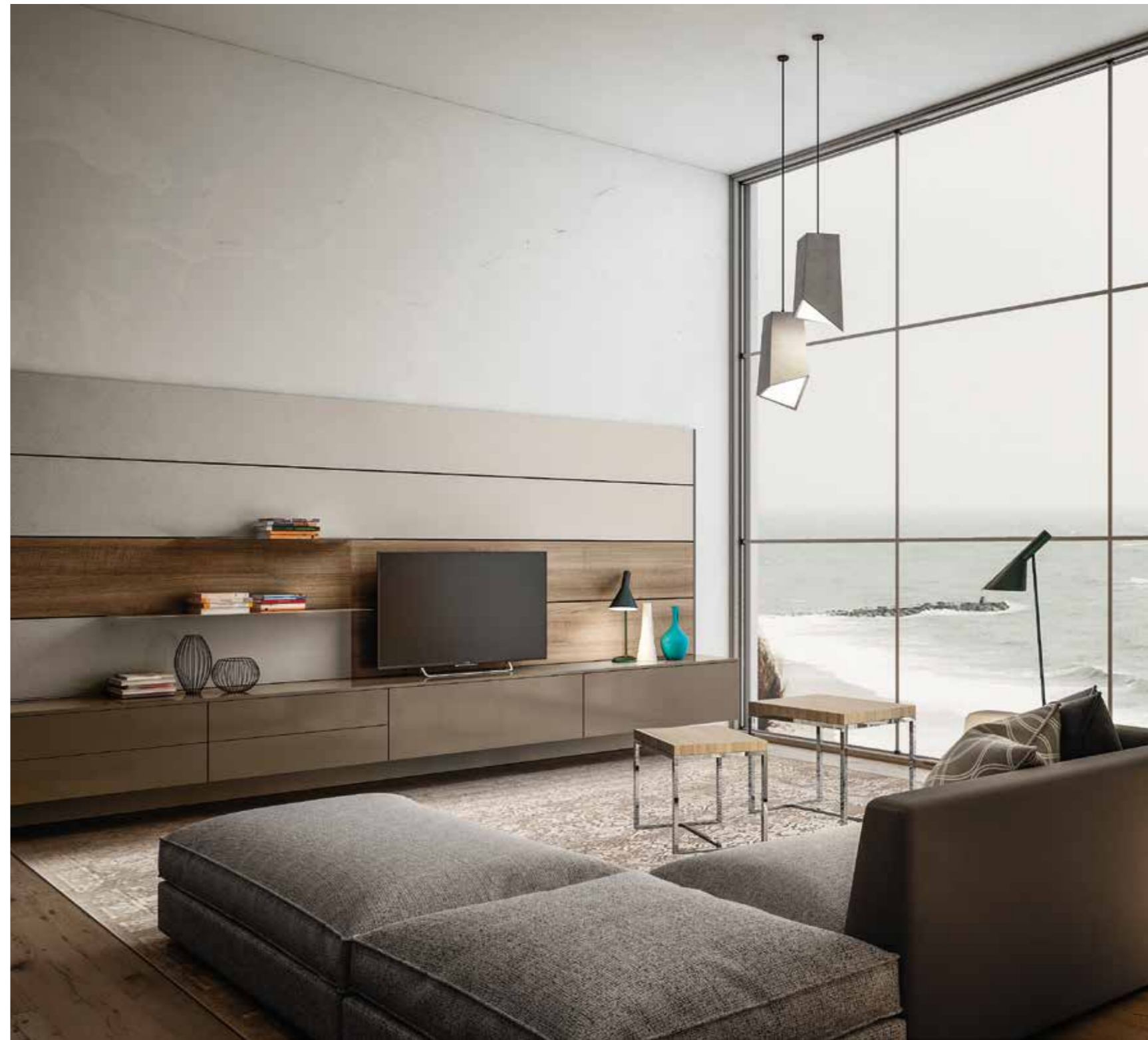

Kali ecomalta silicio, Time laccato lucido carruba, Kali noce Italia
 Kali eco-silica mortar finish, Time gloss carrob lacquer, Kali Italian walnut
 Kali ecomalta silicium, Time laqué brillant carruba, Kali noyer Italia
 Kali ecomortero silicio, Time lacado brillante algarroba, Kali nogal Italiano



.02

Una composizione easy parla di ambienti giovani e contemporanei. La palette cromatica in finitura opaca è composta da Time laccato opaco nebbia, muschio, oliva e carta da zucchero. Gli schienali coordinati aumentano lo spazio contenitivo. Le madie con anta a battente in laccato opaco verde muschio e verde oliva, completano l'ambiente.

An easy, young and contemporary composition. The colour palette of matt finishes comprises Time laqué mat nebbia, vert mousse, olive and sugar paper lacquer. Coordinated back panels extend the amount of storage space. Cupboards with leaf doors in Time laqué mat couleur vert mousse et vert olive, complètent la décoration.

Une composition easy, jeune et contemporaine. La palette chromatique en finition mate est composée de Time laqué mat nebbia, vert mousse, olive et bleu turquoise. Les crédences coordonnées augmentent l'espace de rangement. Les bahuts avec des portes en Time laqué mat couleur vert mousse et vert olive, complètent la décoration.

Una composición sencilla, joven y moderna. La paleta cromática de acabado mate está compuesta por Time lacado mate niebla, musgo, oliva y azul pastel. Las traseras coordinadas aumentan el espacio a disposición. Los aparadores con puerta batiente de Time lacado mate verde musgo y verde oliva, completan el ambiente.



Time laccato opaco nebbia, verde oliva, verde muschio, carta da zucchero
 Time matt mist grey, olive green, moss green, sugar paper lacquer
 Time laqué mat nebbia, vert olive, vert mousse, bleu turquoise
 Time lacado mate niebla, verde oliva, verde musgo, azul pastel



.03

Una wall unit complessa e contenitiva per eccellenza. Composta dagli elementi Factory in finitura brunita, abbinati allo schienale in Kali noce bruno e a basi sospese laccate opaco grigio foca.

A complex wall unit with exceptional storage space. It comprises Factory units with a burnished finish, a Kali brown walnut back panel and wall-hung base units in Time matt seal grey lacquer.

Un mur complexe et de rangement par excellence. Composé avec les éléments Factory en finition brunie, combinés avec la crédence en Kali noyer brun et avec les bases suspendues Time laqué mat gris phoque.

Una pared compleja y apta para contener. Compuesta por elementos Factory de acabado bruñido, combinados con la trasera de Kali nogal oscuro y con los muebles suspendidos de Time lacado mate gris foca.





Kali noce bruno, Factory brunito, Time laccato opaco grigio foca
 Kali brown walnut, Factory burnished finish, Time matt seal grey lacquer
 Kali noyer brun, Factory bruni, Time laqué mat gris phoque
 Kali nogal oscuro, Factory bruñido, Time lacado mate gris foca





.04

Un mosaico decorativo e vibrante composto dagli elementi Air metal in sottilissima lastra da 0,5 mm, pensili in Kali Pet maxximat lavagna e cassetti in Aria larice Vas.

A dynamic decorative mosaic comprising units with Air metal finish in very thin sheet metal, 0.5 mm, wall units in Kali Pet maxximat slate grey and drawers in Aria Vas larch.

Une mosaïque décorative et vibrante composée d'éléments Air métal réalisés avec une feuille très fine de 0,5 mm, éléments hauts en Kali Pet maxximat ardoise et tiroirs en Air mélèze Vas.

Un mosaico decorativo y vibrante compuesto por los elementos Air metal en una chapa muy delgada de 0,5 mm, muebles altos Kali Pet maxximat pizarra y cajones de Aria alerce Vas.



Kali Pet maxximatt lavagna, Aria larice Vas, Air metal
 Kali Pet maxximatt slate grey, Aria Vas larch, Air metal finish
 Kali Pet maxximatt ardoise, Aria mélèze Vas, Air metal
 Kali Pet maxximatt pizarra, Aria alerce Vas, Air metal



.05

Una sobria composizione in Kali pietra grigia e basi a cassetto in Kali rovere cuoio, completata dalla madia con basamento Aria altezza 24 cm in metallo brunito. I vani a giorno Air in metallo sono inseriti sui pensili verticali e lasciati liberi sulla parete, per un effetto estetico coordinato e leggero.

A sober composition in Kali grey stone, base units with drawers in Kali hide oak, complemented with an Aria cupboard with base support H. 24 cm in burnished metal. Air metal finish open units are inserted in vertical wall units and left mobile on the wall for a light and coordinated aesthetic look.

Une sobre composition en Kali pierre gris et des bases à tiroir en Kali chêne cuir, complétée par le bahut avec une base Air H 24 cm en métal bruni. Les compartiments ouverts Air en métal sont insérés sur les éléments hauts verticaux et posés librement sur le mur, pour un effet esthétique coordonné et léger.

Una sobria composición de Kali piedra gris y mueble bajo con cajón de Kali roble cuero, se completa con el aparador con base Aria H 24 cm de metal bruñido. Los elementos abiertos Air de metal están introducidos en muebles altos verticales y quedan libres en la pared, obteniendo un efecto coordinado y ligero.



Kali rovere cuoio, Kali pietra grigio, Air metal
 Kali hide oak, Kali grey stone, Air metal
 Kali chêne cuir, Kali pierre gris, Air métal
 Kali roble cuero, Kali piedra gris, Air metal



.06

Fini accostamenti caratterizzano un ambiente dominato dal legno e dal metallo. I toni dei pensili laccato grigio neutro, della boiserie a tutta parete e degli elementi Air metal si stemperano nel laminato poro registro Oregon di basi e madie. Toni caldi e freddi si smorzano a vicenda, dando vita ad una soluzione living dalla spiccata eleganza. Il gusto ricercato si esprime anche nel design, ad esempio attraverso le sorprendenti madie sospese.

Refined combinations in a context where wood and metal are the predominant features. The shades of neutral grey lacquer wall units, of the wall panelling along the full length of the wall and Air metal elements blend with Oregon register pore laminate base units and cupboards. Warm and cool shades soften each other, creating a living space solution of outstanding elegance. The refined look can also be seen in the design, for example, in the surprising suspended cupboards.

Les juxtapositions caractérisent un espace dominé par le bois et par le métal. Les tons des éléments hauts laqués gris neutre, de la boiserie appliquée sur toute la paroi et des éléments Air metal se fondent dans le laminé à pore diffus Oregon des bases et des bahuts. Les couleurs chaudes et froides s'atténuent mutuellement, en donnant vie à une solution living de grande élégance. Le style s'exprime aussi dans le design, par exemple à travers les surprenants bahuts suspendus.

Delicadas combinaciones caracterizan un ambiente dominado por la madera y el metal. Los tonos de los muebles altos lacados grises neutro, del revestimiento de madera de toda la pared y de los elementos Air metal se difuminan en el laminado con poro registro Oregon de los muebles bajos y aparadores. Tonos cálidos y fríos se mezclan entre sí, dando vida a una solución living de gran elegancia. El gusto refinado se refleja también en el diseño, como los increíbles aparadores suspendidos.





Cloe laccato opaco grigio neutro, Cloe laminato poro registro Oregon, elementi Air metal
 Cloe neutral grey matt lacquer, Cloe Oregon register pore laminate, Air metal elements
 Cloe laqué mat gros neutre, Cloe laminé à pore diffus Oregon, éléments Air metal
 Cloe lacado mate gris neutro, Cloe laminado con poro registro Oregon, elementos Air metal



.07

Una parete completamente attrezzata e contenitiva. Lo schienale in Kali eucalipto noce supporta i pensili in Kali Fenix grigio Londra e i vani a giorno Air in finitura metal. La mensola a forte spessore crea un comodo appoggio smart per il laptop, una micro postazione che sparisce nell'estetica globale.

A completely accessorized wall unit with exceptional storage space. A back panel in Kali eucalyptus walnut supports wall units in Kali London grey Fenix and open units with Air metal finish. A thick shelf provides a practical smart top for a laptop, a mini workstation that blends in with the overall aesthetic look.

Un mur complètement aménagé et de rangement. La crédence en Kali eucalyptus noyer soutient les éléments hauts en Kali Fenix gris Londres et les compartiments ouverts Air finition métal. L'étagère de large épaisseur crée un appui pratique et smart pour le laptop, un micro-endroit qui disparaît dans l'esthétique globale.

Una pared completamente equipada y con amplio espacio para contener. La trasera de Kali eucalipto nogal sostiene los estantes de Kali Fenix gris Londres y los elementos abiertos Air de acabado metal. El estante de espesor grueso es un apoyo cómodo para el portátil, una pequeña zona dedicada al PC que desaparece en la estética del conjunto.



Kali eucalipto noce, Kali Fenix grigio Londra, Air metal
 Kali eucalyptus walnut, Kali London grey Fenix, Air metal
 Kali eucalyptus noyer, Kali Fenix gris Londres, Air metal
 Kali eucalipto nogal, Kali Fenix gris Londres, Air metal

.08

Giovane e dinamico, pensato per essere vissuto in tutte le sue qualità. La mensola con boiserie in Kali noce Italia, forma una work-station con piccoli vani a giorno. La composizione si amplia con le basi sospese in Kali Fenix castoro Ottawa e il pensile verticale in Kali Pet lavagna maximatt. Un ambiente unico, ma molto versatile.

Young and dynamic, designed for all its qualities to be appreciated. A shelf with wall panelling in Kali Italian walnut creates a workstation with small open units. The composition extends with wall-hung base units in Kali Ottawa beaver Fenix and a vertical wall unit in Kali Pet maximatt slate grey. A single yet very versatile room.

Jeune et dynamique, conçu pour être vécu dans toutes ses qualités. L'étagère avec boiserie en Kali noyer Italia, forme une work-station avec de Petits compartiments ouverts. La composition s'élargit avec les bases suspendues en Kali castor Ottawa et l'élément haut vertical en Kali Pet, ardoise maximatt. Un espace unique, mais très versatile.

Joven y dinámico, pensado para vivir todas sus cualidades. El estante con boiserie de Kali nogal italiano, forma una estación de trabajo con pequeños elementos abiertos. La composición se amplía con los muebles bajos suspendidos de Kali Fenix castor Ottawa y el mueble alto suspendido vertical Kali Pet pizarra maximatt. Un espacio único, pero muy versátil.

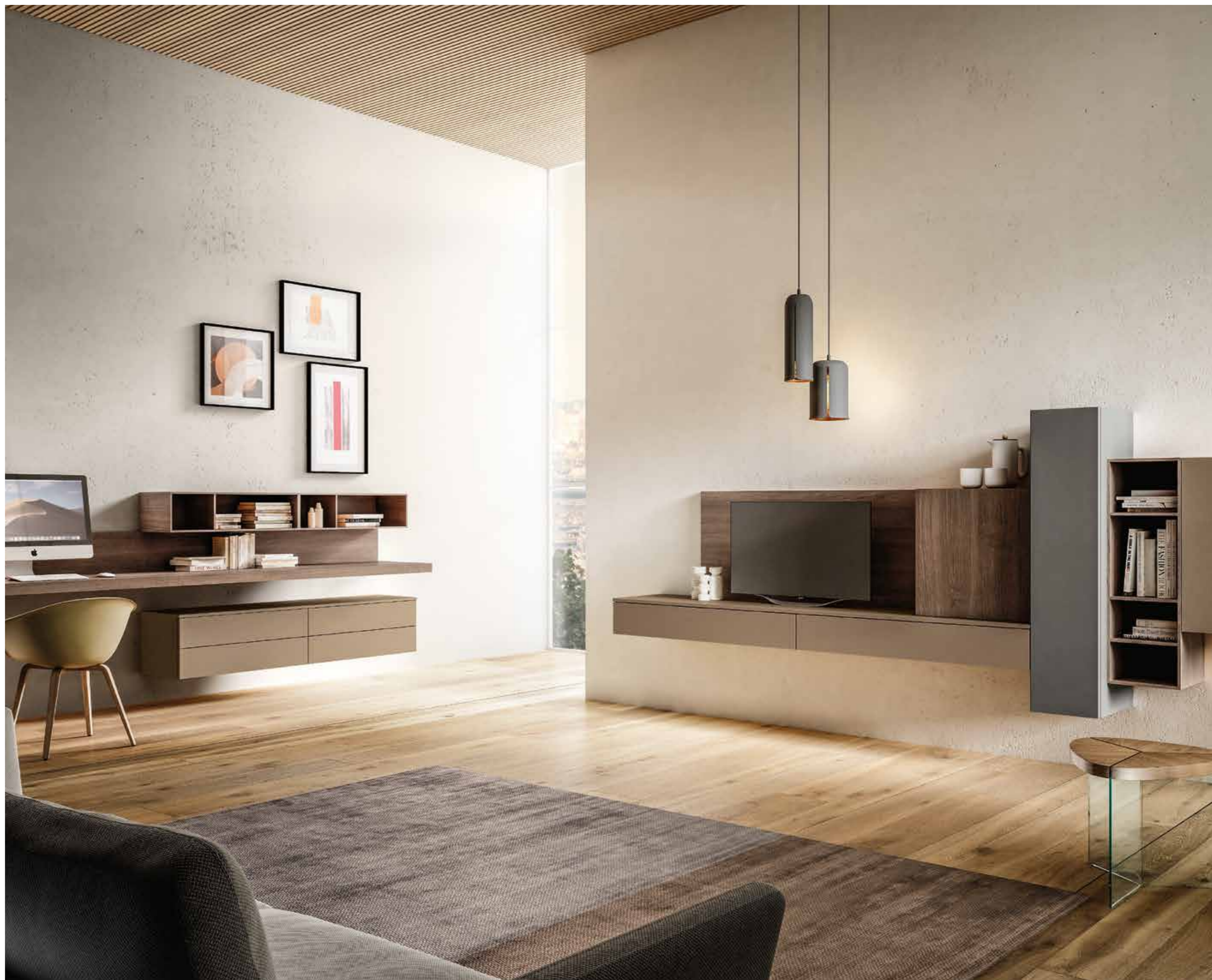



Kali Fenix castoro Ottawa, Kali Pet lavagna maxximatt, Kali noce Italia
 Kali Ottawa beaver Fenix, Kali Pet maxximatt slate grey, Kali Italian walnut
 Kali Fenix castor Ottawa, Kali Pet ardoise maxximatt, Kali noyer Italia
 Kali Fenix castor Ottawa, Kali Pet pizarra maxximatt, Kali nogal italiano

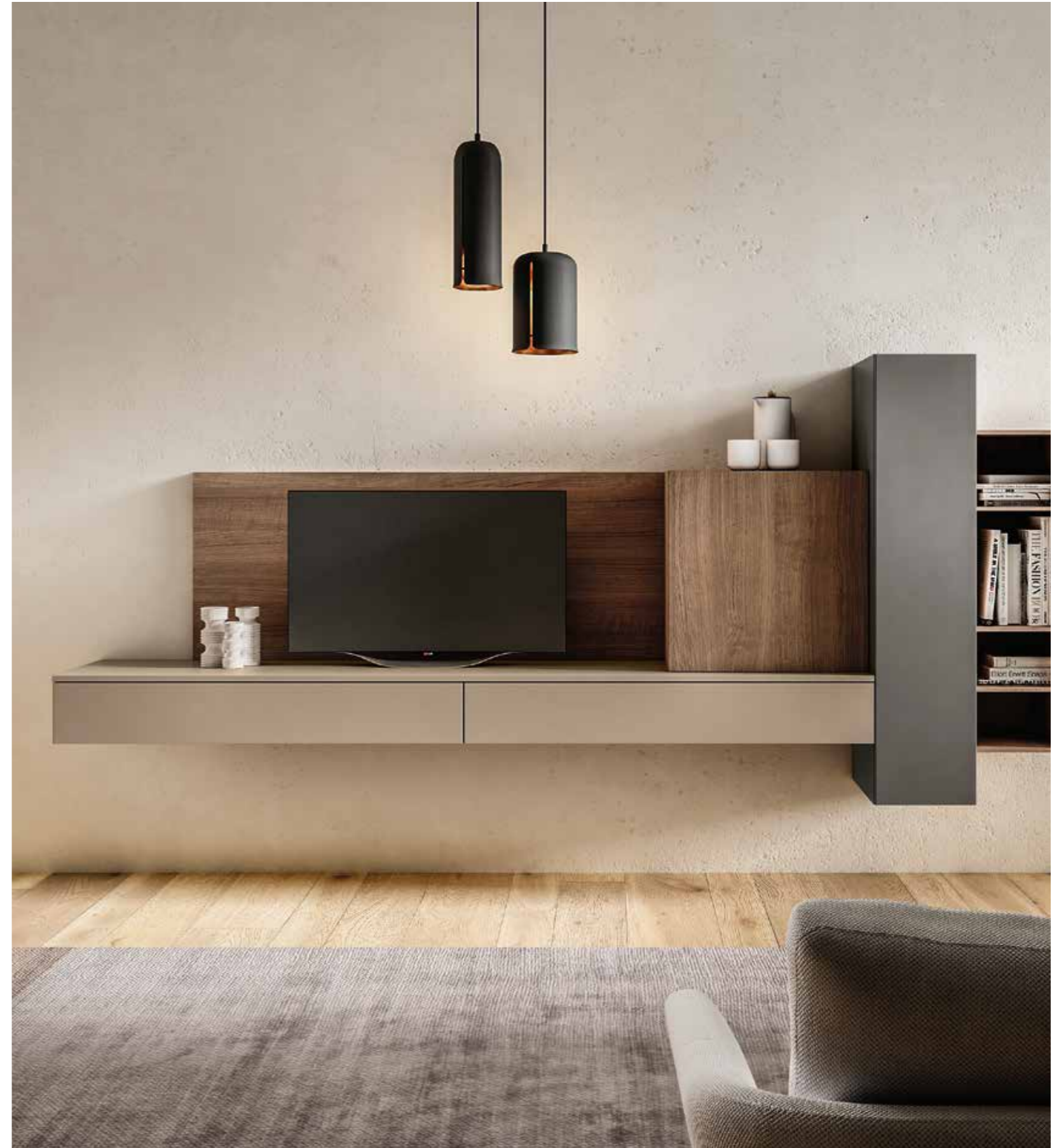

.09

Il fascino dell'arredo integrato perfettamente nel progetto architettonico. La possibilità infinita di modularità si esprime nell'alternanza di boiserie e vani a giorno in Kali eucalipto noce, ante in Time metallizzato ossidato e Factory brunito con vetro fumé. La complessità degli elementi diventa struttura stessa dell'ambiente abbracciando le pareti del living.

The charm of furnishings perfectly integrated with architectural design. Countless modular solutions are expressed with alternating wall panelling and open units in Kali eucalyptus walnut, doors with Time oxidized metallic finish and Factory burnished finish with grey tinted glass. The complexity of furniture elements becomes the very structure of the room, embracing the walls of the living space.

Le charme du mobilier parfaitement intégré dans le projet architectural. La possibilité infinie de modularités s'exprime à travers l'alternance de boiseries et de compartiments ouverts en Kali eucalyptus noyer, portes en Time métallisé oxydé et Factory bruni avec verre fumé. La complexité des éléments devient la structure de l'espace en embrassant les murs du living.

El encanto del mobiliario integrado perfectamente en el proyecto arquitectónico. La posibilidad infinita de la composición modular se expresa en el alternarse de boiserie y elementos abiertos de Kali eucalipto nogal, puertas de Time metalizado y Factory bruñido con vidrio ahumado. La complejidad de los elementos se convierte en estructura del ambiente y abraza las paredes del living.





Time metallizzato ossidato, Kali eucalipto noce, Factory brunito, vetro fumè
 Time oxidized metallic finish, Kali eucalyptus walnut, Factory burnished finish, grey tinted glass
 Time métallisé oxydé, Kali eucalyptus noyer, Factory bruni, verre fumé
 Time metalizado oxidado, Kali eucalipto nogal, Factory bruñido, vidrio ahumado



.10

Un collage dal gusto molto personale. La media è giocata con ante di diversi colori nelle finiture Time laccati opachi, come il verde bosco, il verde muschio e Aria larice Cortina che prosegue nella boiserie e nei moduli a giorno. La palette cromatica caratterizza anche le due madie sospese sulla base h. 24 cm in finitura brunito. Le basi sospese sono in Time laccato opaco verde oliva.

A collage in a very personal style. An attractive cupboard with doors in different colours including Time matt wood green and moss green lacquer and Aria Cortina larch, continuing with wall panelling and open units. The colour palette is also a striking feature of two wall-hung cupboards over a base unit, h. 24 cm, with burnished finish. Wall-hung base units are in Time matt olive green lacquer.

Un collage au goût très personnel. Le bahut présente un jeu de portes de différentes couleurs dans les finitions Time laqué mat, comme le vert bois, le vert mousse et Aria mélèze Cortina qui se poursuit dans la boiserie et dans les modules ouverts. La palette chromatique caractérise aussi les deux bahuts suspendus sur la base h. 24 cm dans la finition bruni. Les bases suspendues sont en revanche en Time laqué mat vert olive.

Un collage muy personal. El aparador tiene puertas de colores diferentes con acabado Time lacado mate, como el verde bosque, el verde musgo y Aria alerce Cortina que sigue en el revestimiento de madera y en los módulos abiertos. La paleta cromática también caracteriza los aparadores suspendidos con base de h. 24 cm y con acabado bronce bruñido. Los muebles bajos suspendidos tienen acabado Time lacado mate verde aceituna.



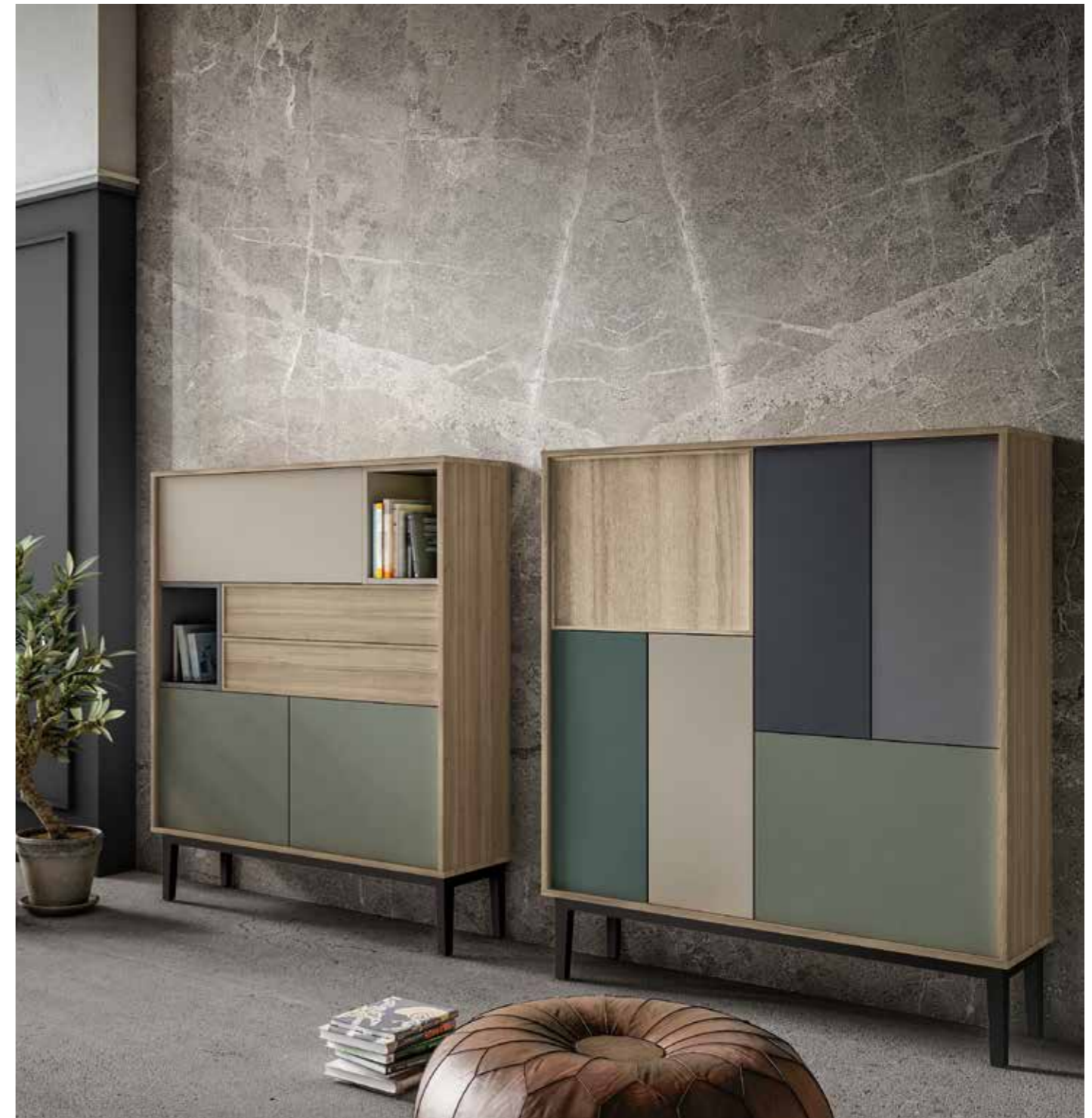

Time laccato opaco verde oliva, verde muschio, verde bosco, grigio ombra, blu notte. Aria larice Cortina, basamento Aria brunito
 Time matt olive green, moss green, wood green, shadow grey and dark blue lacquer. Aria Cortina larch, Aria burnished base support
 Time laqué mat vert olive, vert mousse, vert bois, gris ombre, bleu nuit. Aria mélèze Cortina, base Aria bruni
 Time lacado mate verde aceituna, verde musgo, verde bosque, gris sombra, azul noche. Aria alerce Cortina, base Aria bronce bruniado

.11

Uno spazio classico ricco di fascino, creato dai pensili orizzontali in Kali rovere biondo e Kali ecomalta cementho; le basi sono in Kali Pet maximatt lavagna ed ecomalta cemento. Affascinante ed estremamente contenitiva l'armadiatura con ante a tutta altezza, che scompare come fosse una parete. Il profilo che funge da maniglia disegna una geometria minimale.

A classic space full of charm, created with horizontal wall units in Kali blond oak and Kali eco-cement mortar; base units are in Kali Pet matt slate grey and eco-cement mortar. Charming cupboards with exceptional storage space have full-length doors that disappear as if they were a wall. The grip profile handle is a feature of a minimalist design.

Un espace classique riche en charme, crée par des éléments horizontaux en Kali chêne blond, Kali ecomalta ciment; les bases sont en Kali Pet ardoise mate et ecomalta ciment. Fascinant et extrêmement spacieux, le placard avec des portes sur la hauteur, qui disparaît comme un mur. Le profilé qui sert de poignée dessine une géométrie minimale.

Un espacio clásico rico de encanto, creado por muebles altos horizontales de Kali roble claro, Kali ecomortero cemento; los muebles bajos son Kali Pet pizarra mate y ecomortero cemento. Encantador y con gran capacidad el armario con puertas que ocupan toda la altura, desaparece como si fuera una pared. El perfil que sirve de tirador dibuja una geometría minimalista.





Kali ecomalta cementho, Kali Pet maximatt lavagna, Kali rovere biondo
 Kali eco-cement mortar, Kali Pet matt slate grey, Kali blond oak
 Kali ecomalta ciment, Kali Pet ardoise mate, Kali chêne blond
 Kali ecomortero cemento, Kali Pet pizarra mate, Kali roble claro

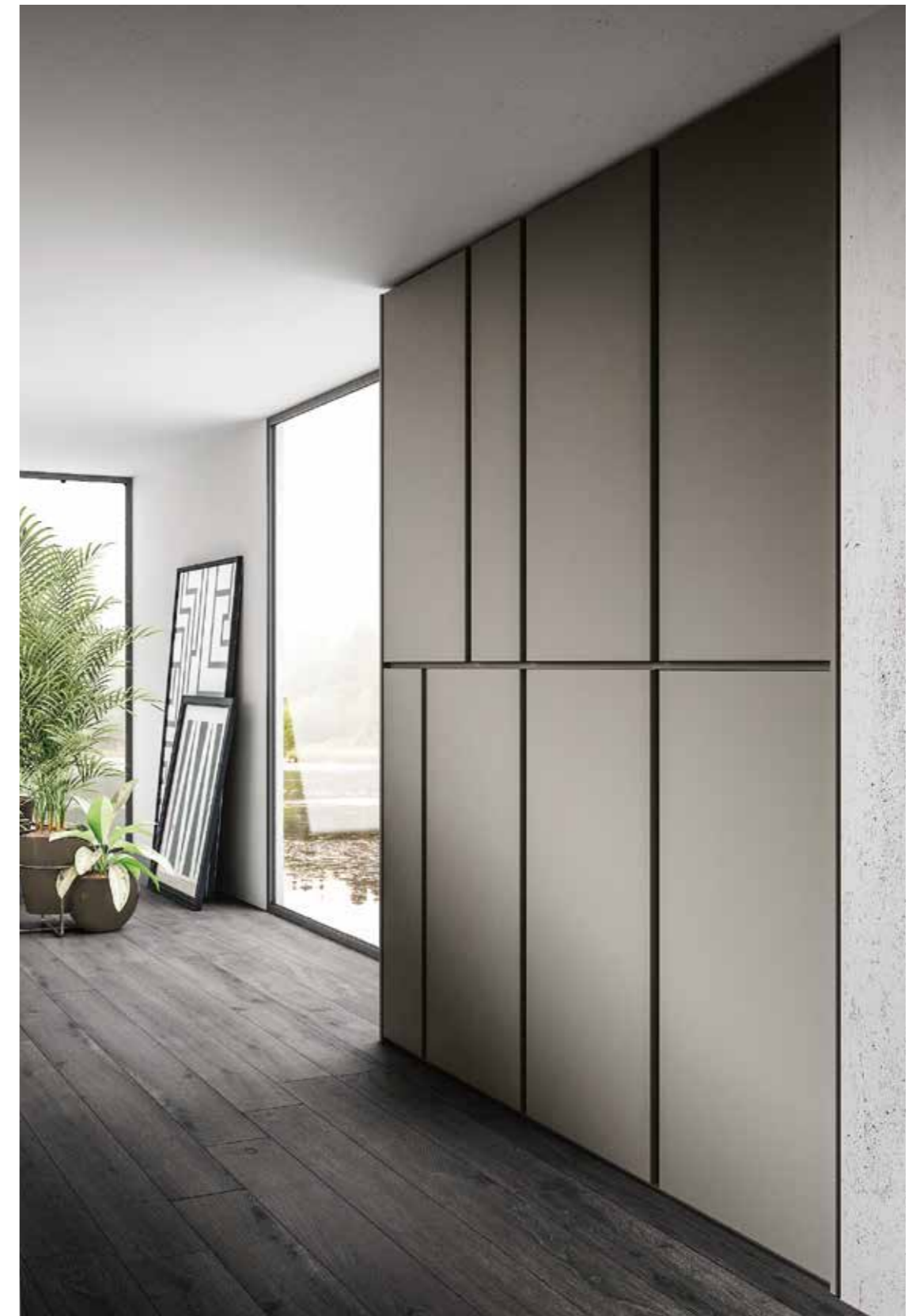

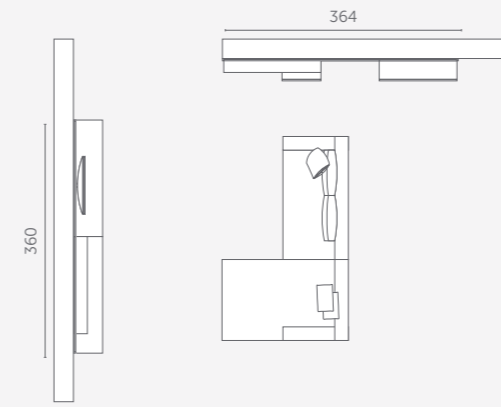

.01

Kali ecomalta silicio, Time laccato lucido carruba, Kali noce Italia
 Kali eco-silica mortar finish, Time gloss carrob lacquer, Kali Italian walnut
 Kali ecomalta silicium, Time laqué brillant carruba, Kali noyer Italia
 Kali ecomortero silicio, Time lacado brillante algarroba, Kali nogal Italiano

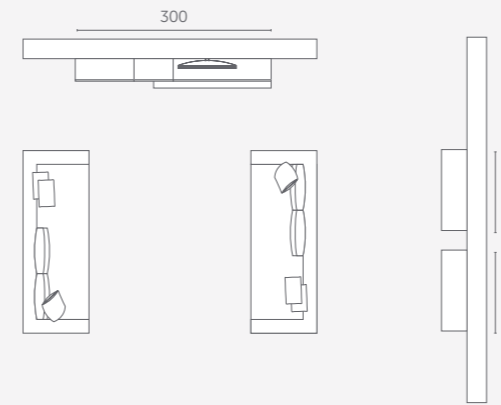

.02

Time laccato opaco nebbia, verde oliva, verde muschio, carta da zucchero
 Time matt mist grey, olive green, moss green, sugar paper lacquer
 Time laqué mat nebbia, vert olive, vert mousse, bleu turquoise
 Time lacado mate niebla, verde oliva, verde musgo, azul pastel

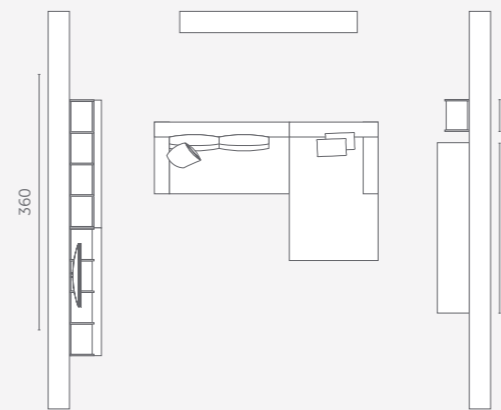

.03

Kali noce bruno, Factory brunito, Time laccato opaco grigio foca
 Kali brown walnut, Factory burnished finish, Time matt seal grey lacquer
 Kali noyer brun, Factory bruni, Time laqué mat gris phoque
 Kali nogal oscuro, Factory bruñido, Time lacado mate gris foca

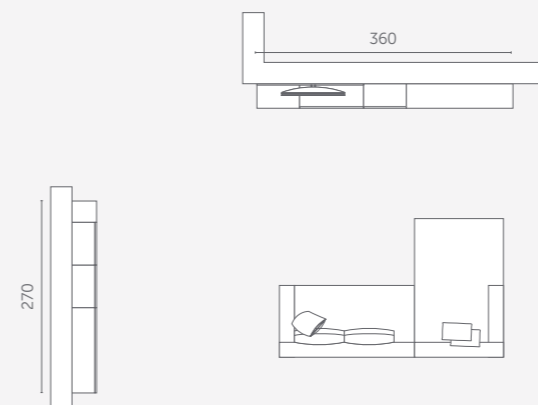

.04

Kali Pet maxximatt lavagna, Aria larice Vas, Air metal
 Kali Pet maxximatt slate grey, Aria Vas larch, Air metal finish
 Kali Pet maxximatt ardoise, Aria mélèze Vas, Air metal
 Kali Pet maxximatt pizarra, Aria alerce Vas, Air metal

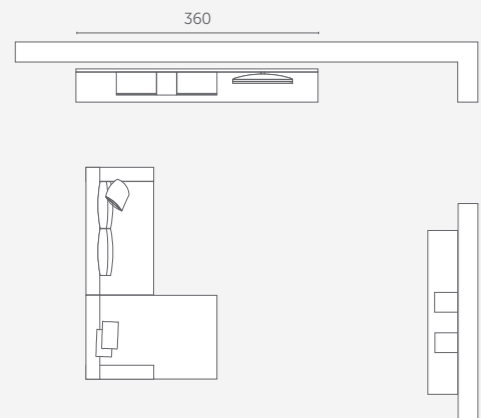

.05

Kali rovere cuoio, Kali pietra grigio, Air metal
 Kali hide oak, Kali grey stone, Air metal
 Kali chêne cuir, Kali pierre gris, Air métal
 Kali roble cuero, Kali piedra gris, Air metal

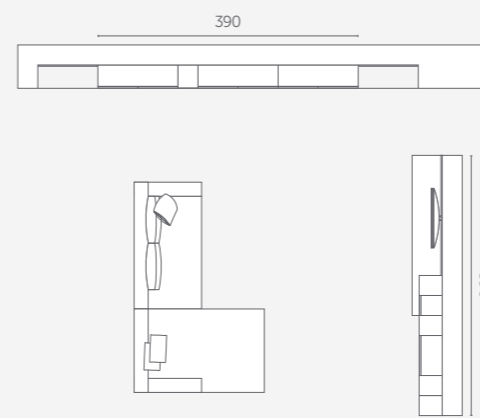

.09

Time metallizzato ossidato, Kali eucalipto noce, Factory brunito, vetro fumè
 Time oxidized metallic finish, Kali eucalyptus walnut, Factory burnished finish, grey tinted glass
 Time métallisé oxydé, Kali eucalyptus noyer, Factory bruni, verre fumé
 Time metalizado oxidado, Kali eucalipto nogal, Factory bruñido, vidrio ahumado

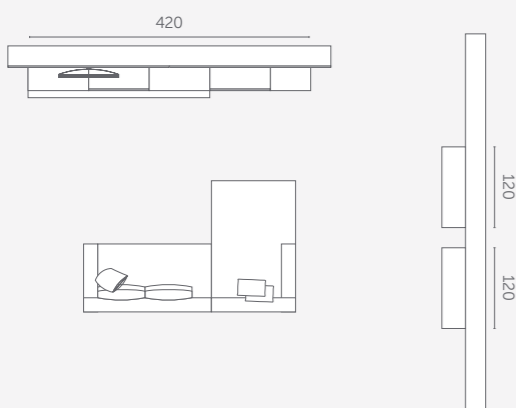

.06

Cloe laccato opaco grigio neutro, Cloe laminato poro registro Oregon, elementi Air metal
 Cloe neutral grey matt lacquer, Cloe Oregon register pore laminate, Air metal elements
 Cloe laqué mat gros neutre, Cloe laminé à pore diffus Oregon, éléments Air metal
 Cloe lacado mate gris neutro, Cloe laminado con poro registro Oregon, elementos Air metal

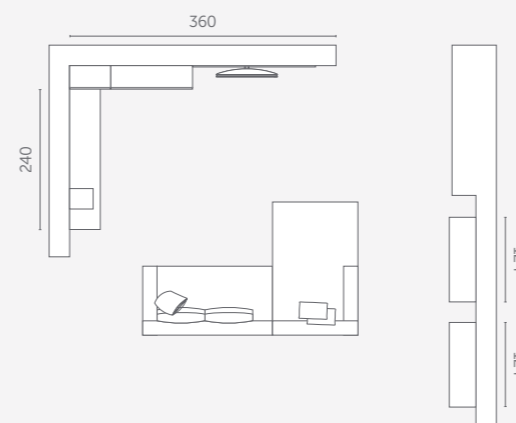

.10

Time laccato opaco verde oliva, verde muschio, verde bosco, grigio ombra, blu notte.
 Aria larice Cortina, basamento Aria brunito
 Time matt olive green, moss green, wood green, shadow grey and dark blue lacquer.
 Aria Cortina larch, Aria burnished base support
 Time laqué mat vert olive, vert mousse, vert bois, gris ombre, bleu nuit.
 Aria mélèze Cortina, base Aria bruni
 Time lacado mate verde aceituna, verde musgo, verde bosque, gris sombra, azul noche.
 Aria alerce Cortina, base Aria bronce bruñido

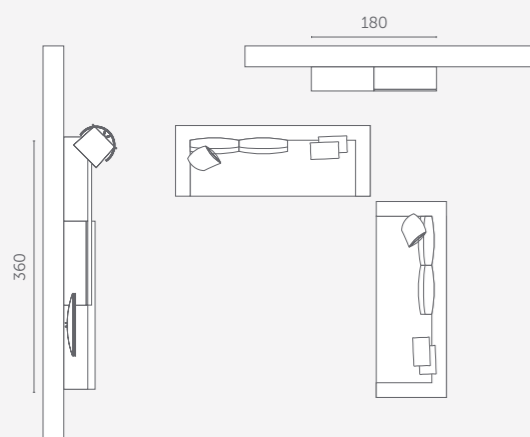

.07

Kali eucalipto noce, Kali Fenix grigio Londra, Air metal
 Kali eucalyptus walnut, Kali London grey Fenix, Air metal
 Kali eucalyptus noyer, Kali Fenix gris Londres, Air metal
 Kali eucalipto nogal, Kali Fenix gris Londres, Air metal

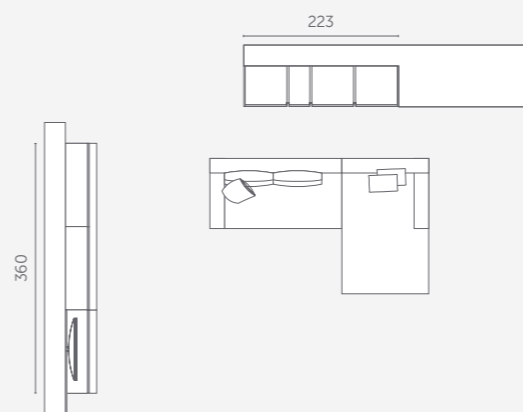

.11

Kali ecomalta cementho, Kali Pet maximatt lavagna, Kali rovere biondo
 Kali eco-cement mortar, Kali Pet matt slate grey, Kali blond oak
 Kali ecomalta ciment, Kali Pet ardoise mate, Kali chêne blond
 Kali ecomortero cemento, Kali Pet pizarra mate, Kali roble claro

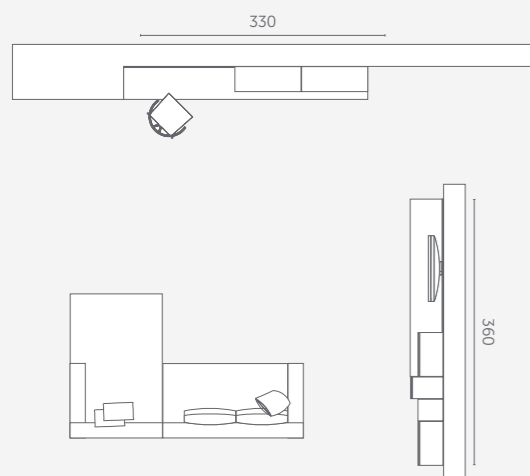

.08

Kali Fenix castoro Ottawa, Kali Pet lavagna maximatt, Kali noce Italia
 Kali Ottawa beaver Fenix, Kali Pet maximatt slate grey, Kali Italian walnut
 Kali Fenix castor Ottawa, Kali Pet ardoise maximatt, Kali noyer Italia
 Kali Fenix castor Ottawa, Kali Pet pizarra maximatt, Kali nogal italiano

.A/01

Misure: L. 240 cm



.A/03

Misure: L. 300 cm



.A/02

Misure: L. 270 cm



.A/04

Misure: L. 330 cm



.B/01

Misure: L. 210 cm



.B/03

Misure: L. 270 cm



.B/02

Misure: L. 240 cm



.B/04

Misure: L. 300 cm



.C/01

Misure: L. 210 cm



.C/03

Misure: L. 270 cm



.C/02

Misure: L. 240 cm



.C/04

Misure: L. 300 cm



.D/01

Misure: L. 210 cm



.D/03

Misure: L. 270 cm



.D/02

Misure: L. 240 cm



.D/04

Misure: L. 300 cm



.E/01

Misure: L. 210 cm



.E/03

Misure: L. 270 cm



.E/02

Misure: L. 240 cm



.E/04

Misure: L. 300 cm



.F/01

Misure: L. 210 cm



.F/03

Misure: L. 270 cm



.F/02

Misure: L. 240 cm



.F/04

Misure: L. 300 cm



.G/01

Misure: L. 210 cm



.G/03

Misure: L. 270 cm



.G/02

Misure: L. 240 cm



.G/04

Misure: L. 300 cm



.H/01

Misure: L. 210 cm



.H/03

Misure: L. 270 cm



.H/02

Misure: L. 240 cm



.H/04

Misure: L. 300 cm



.I/01

Misure: L. 210 x 150 cm



.I/03

Misure: L. 270 x 210 cm



.I/02

Misure: L. 240 x 180 cm



.I/04

Misure: L. 300 x 270 cm





Arredo3 Srl

Via Moglianese, 23 - 30037 Scorzè (VE)
Tel. +39 041 5899111 / Fax +39 041 5899130
www.arredo3.it - arredo3@arredo3.it

